

New Look Collection – Pant Jacket Fabric-Style- Measurement Form

Please print this form, fill it out and mail it to: newlookcollection@gmail.com
Ask a friend, family member or **local tailor** if you need any help.

Your Name:	
Your Height:	
Your Weight:	

Step 1 (Select Fabric)

Although much effort has gone into producing high quality images of the fabrics, we cannot guarantee that your monitor will correctly replicate the colors. Fabrics colors shown in this section may have a 10-15% difference depending on the settings & resolution of your monitor.

Solid



Charcoal Grey
(BSD-001)



Dark Grey
(BSD-002)



Grey
(BSD-003)



Black
(NLC-004)



Blue
(NLC-005)

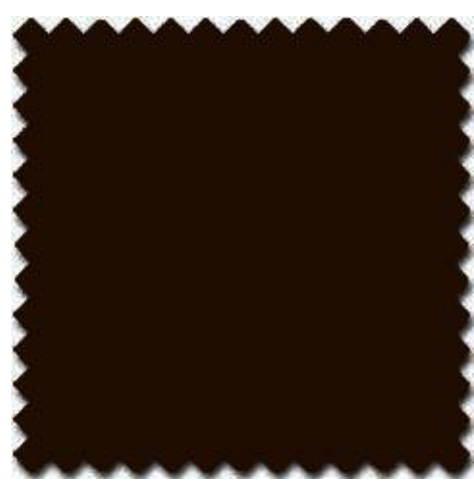

Brown
(NLC-122)

Wide Stripes (2 cms wide – Stripes)



Black With Pink Stripes
(NLC-006)



Black with White Stripes
(NLC-007)

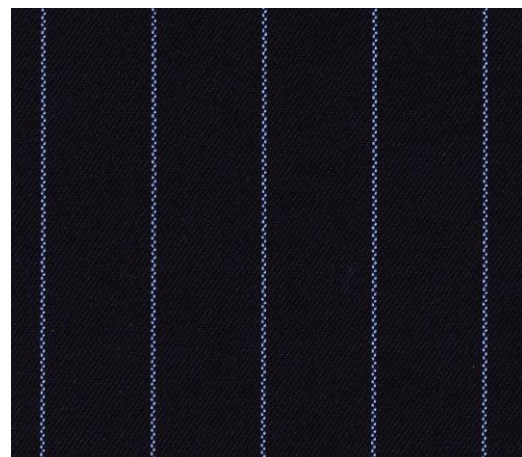

Blue with Sky Blue Stripes
(NLC-008)



Dark Grey with White Stripes
(NLC-009)



Silver Grey with White Stripes
(NLC-010)

Self-Stripes



Black Self Self Stripes
(NLC-011)



Charcoal Grey Self
(NLC-012)



Dark Grey Self
(NLC-013)

Herringbone Stripes

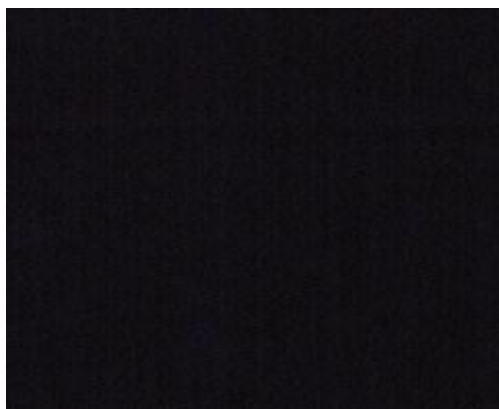

**Black
(NLC-014)**

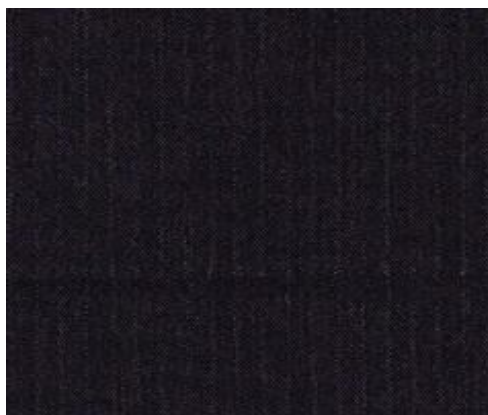

**Dark Grey
(NLC-015)**

**Pinstripe
Stripes: Single White**



**Black
(NLC-016)**



**Blue
(NLC-017)**



**Dark Grey
(NLC-018)**

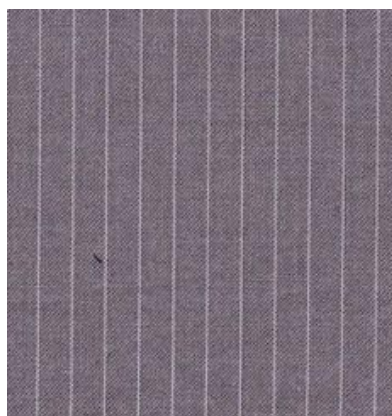

New Look Collection - Custom Tailors | 198/21-23 Moo 9 | Soi Daina Inn | Inside Areca Lodge |
Pattaya | Thailand | +668(0) 891385066 | 0066(0) 38 422067 | www.NLCTailors.com

**Grey
(NLC-019)**

For Further references of fabric:

<http://nlctailors.com/fabric-2/cashmerewool/>

<http://nlctailors.com/fabric-2/berry-for-suiting/>

<http://nlctailors.com/fabric-2/merino-for-suits/>

<http://nlctailors.com/fabric-2/italian-metalic-wool/>

Fabric No:	Please specify
-------------------	----------------

Step 2 (Select Jacket Lining)

The colours displayed in this section are for guidance only.
Actual lining colours may be slightly different.

		
Black	Blue	Red
		
Gold	Silver	Cream

Lining:	Please specify
----------------	----------------

Step 3 (Select Style)

Single Breasted

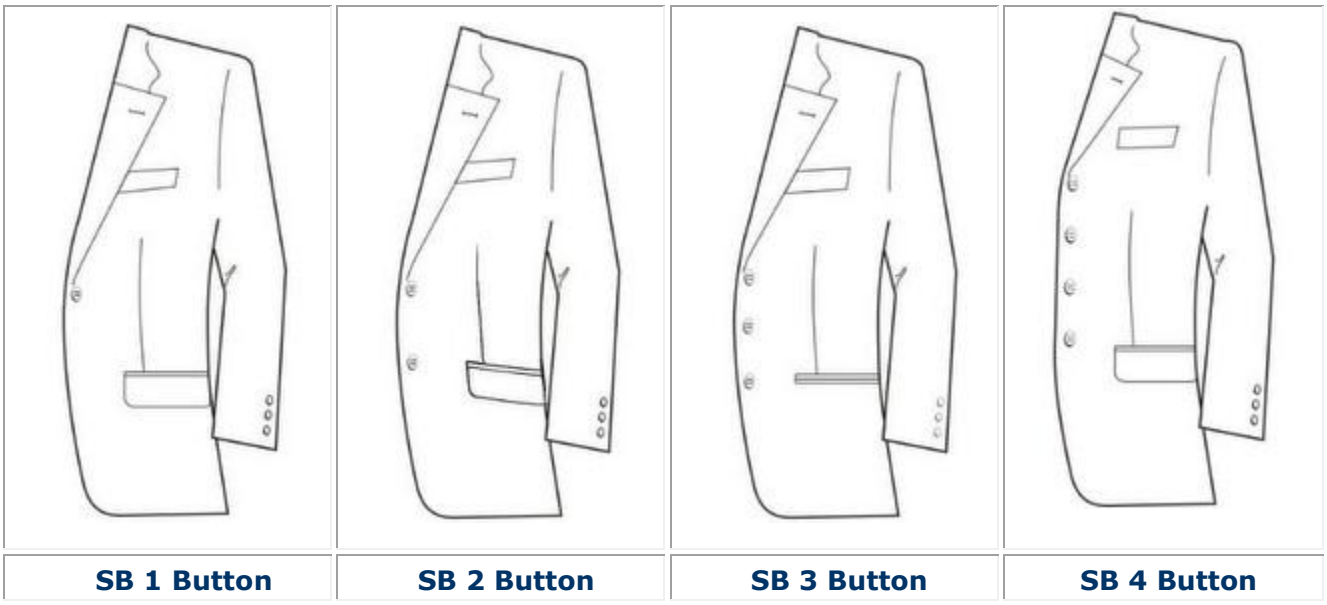

Double Breasted

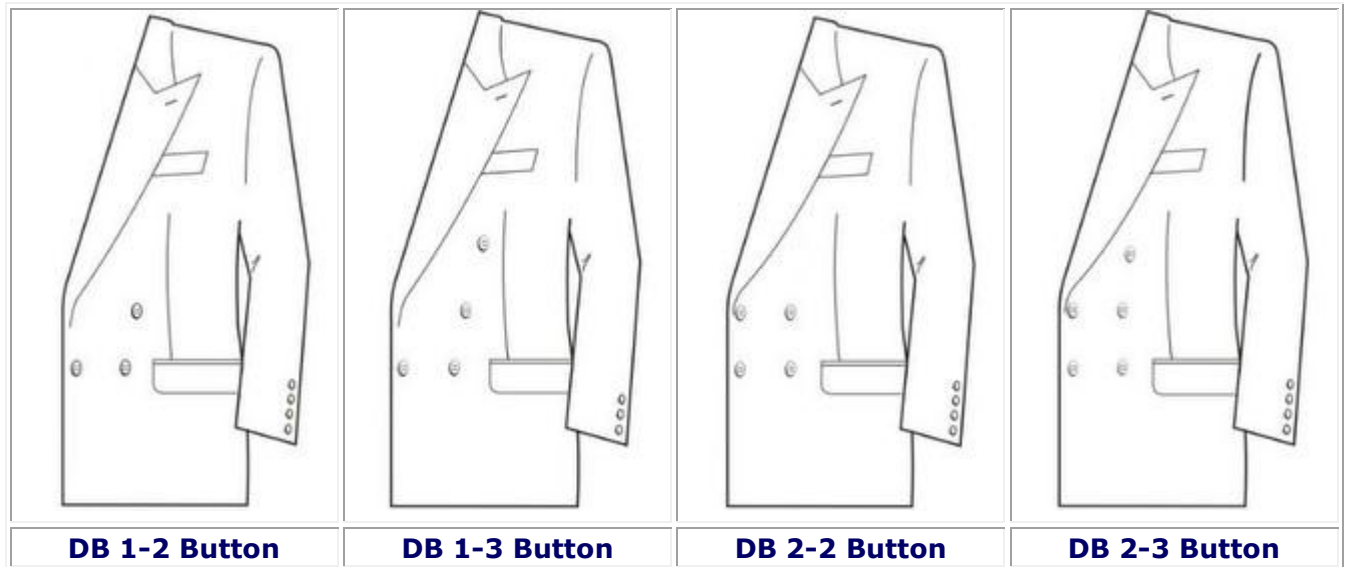

Dinner Suit / Tuxedo Single Breasted

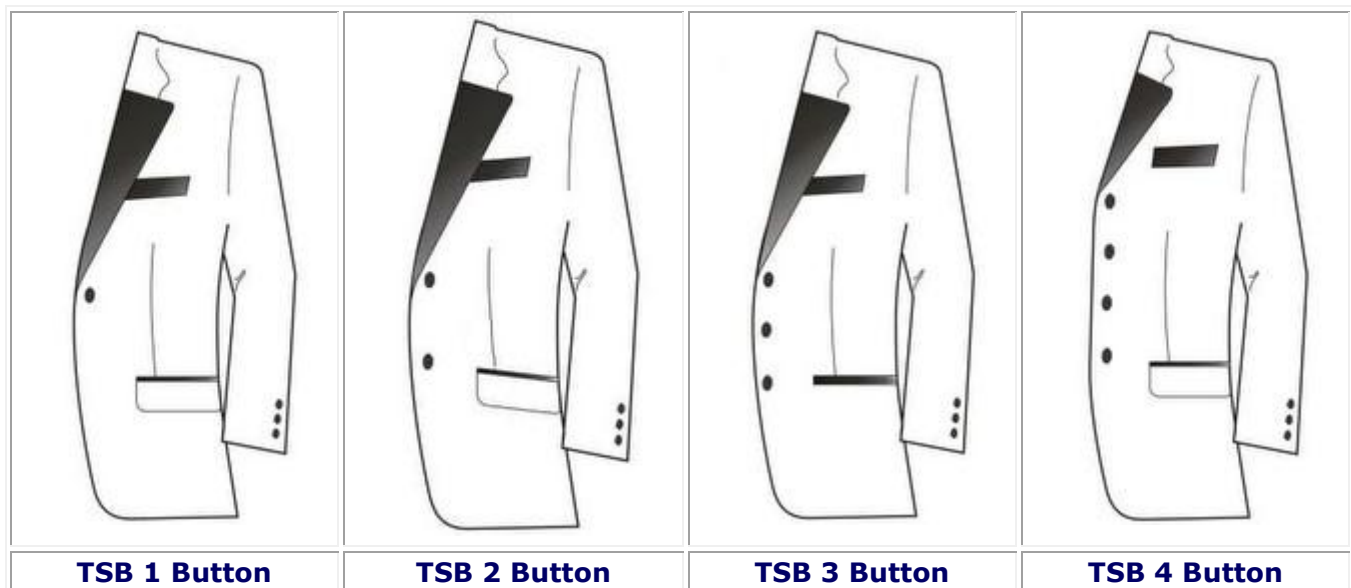

Double Breasted

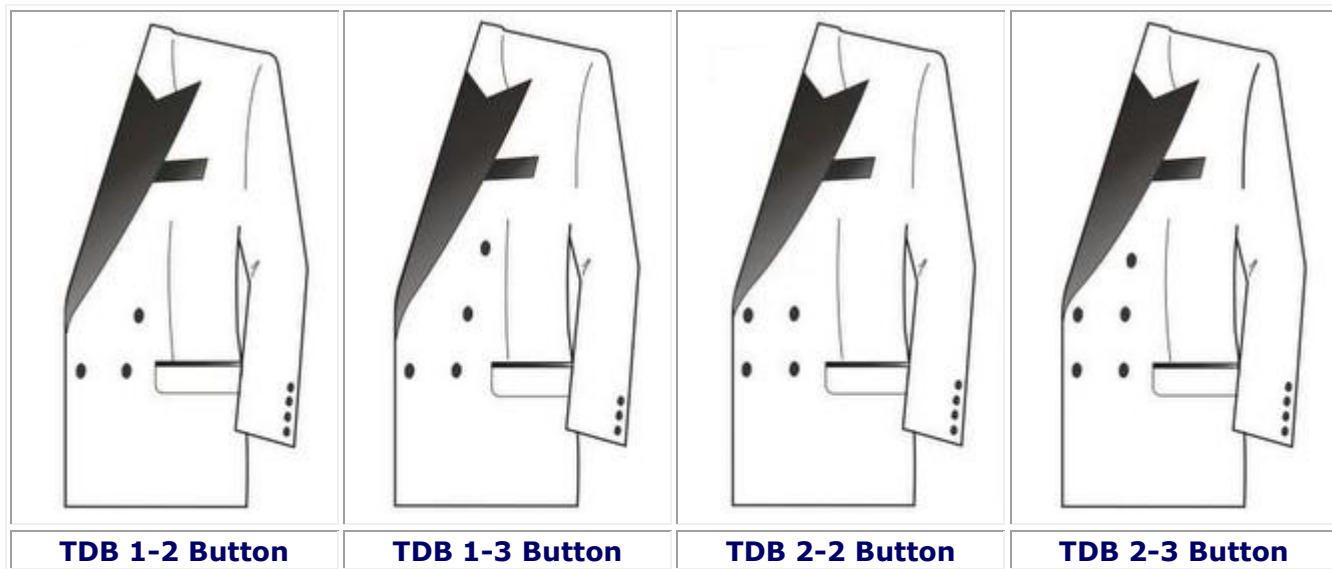

Shawl Collar

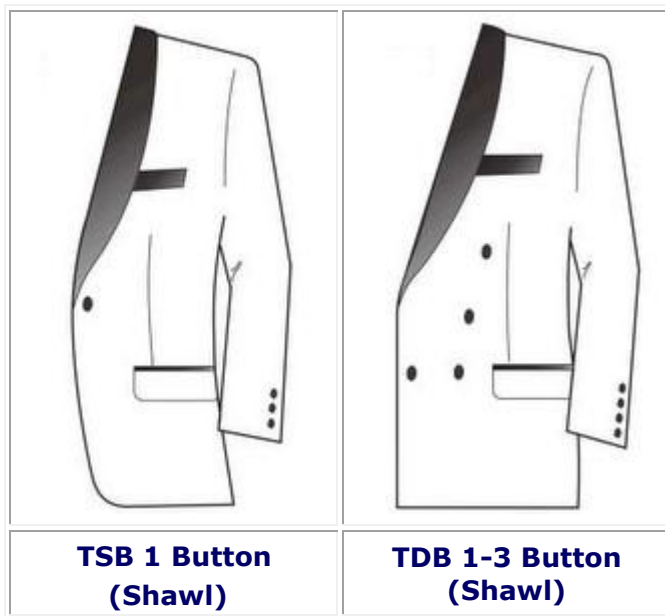

Select Style:	Please specify
----------------------	----------------

Step 4 (Design your Suit)

The following features come as standard:

- Full Interior Polyester Lining
- Outside Right and Left Pockets
- Outside Left Top Pocket
- Outside Left Lapel Button Hole
- Inside Left and Right Pockets
- Inside Ticket Pocket
- Trousers front interior lining to the knee

Design Your Jacket

Lapel Style

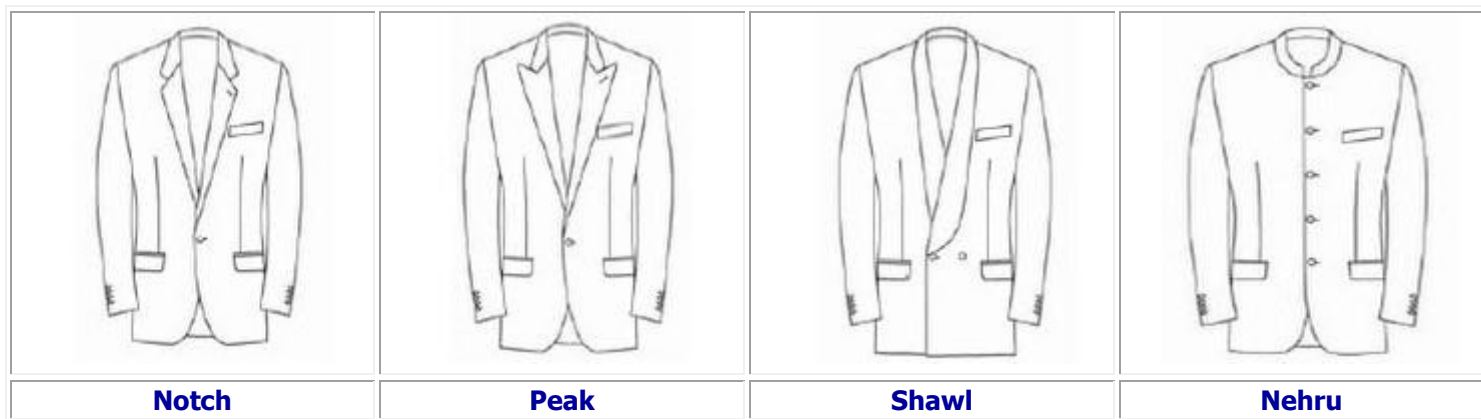

Select Lapel Style:

Please specify

Lapel Width

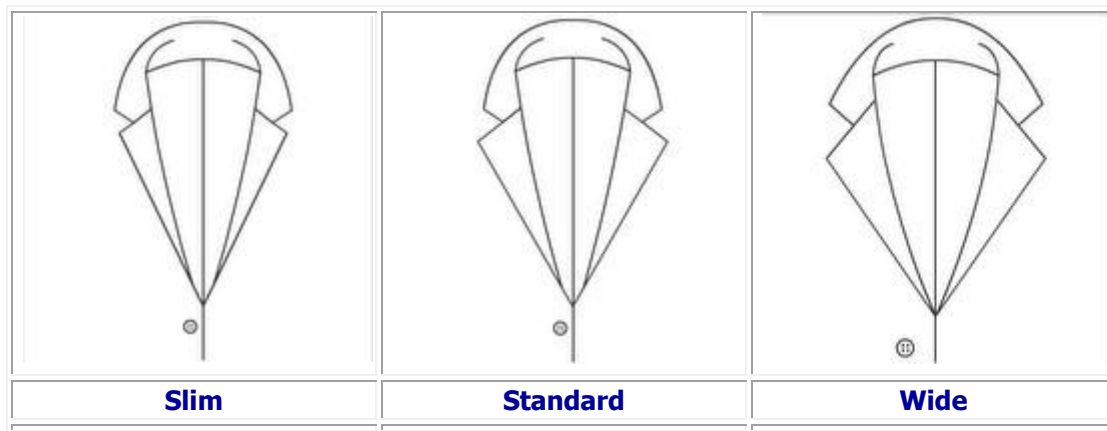

Select Lapel Width:	Please specify
----------------------------	----------------

Satin Lapel:

A tuxedo/dinner jacket usually have satin lapels. Choose your color, or none if you don't want satin lapels.



Satin Lapel:	Please specify (Black\White\None)
---------------------	-----------------------------------

Vent Style



Vent Style:	Please specify
--------------------	----------------

Cuff Buttons

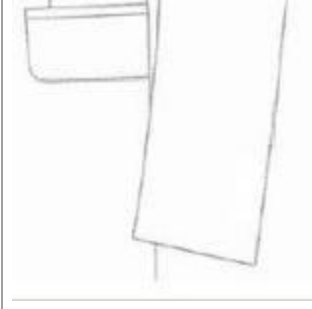
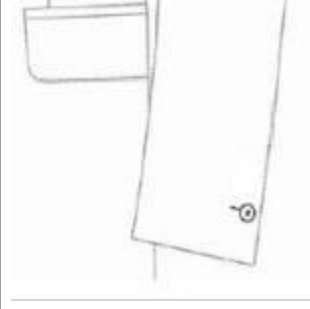
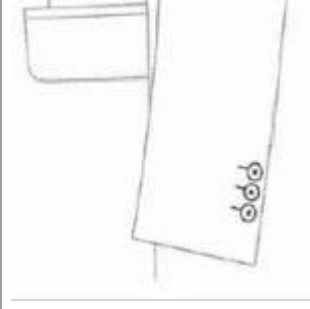
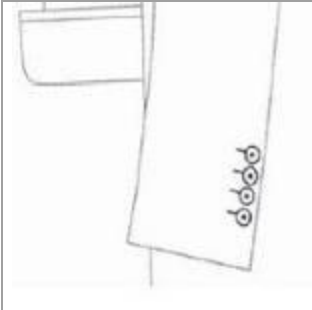
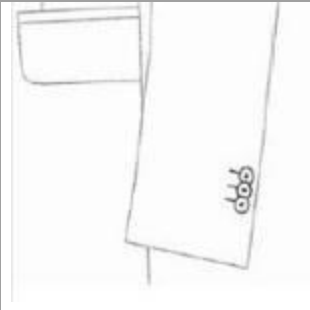
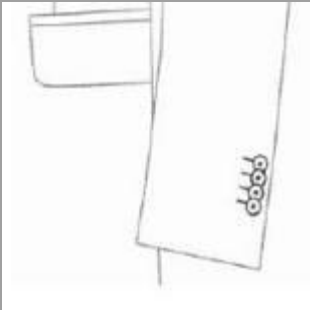
		
No Button	1 Button	3 Buttons
		
4 Buttons	3 Kissing Buttons*	4 Kissing Buttons*

* Not compatible with working/functional button cuffs

Cuff Buttons:	Please specify
----------------------	----------------

Jacket Pocket

		
No Pockets	Straight Pockets	Slanted Pockets

Jacket Pockets:	Please specify
------------------------	----------------

Design Your Trousers

Back Pockets



Back Pockets:	Please specify
----------------------	----------------

Front Pockets

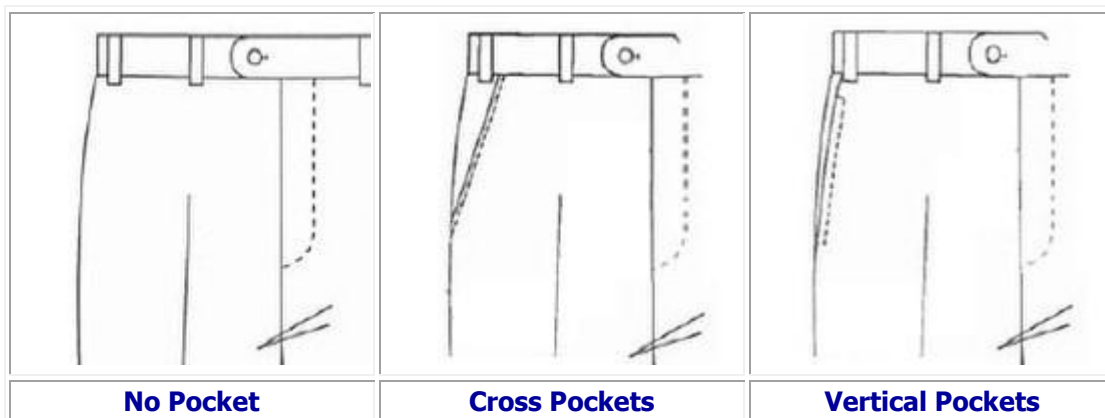

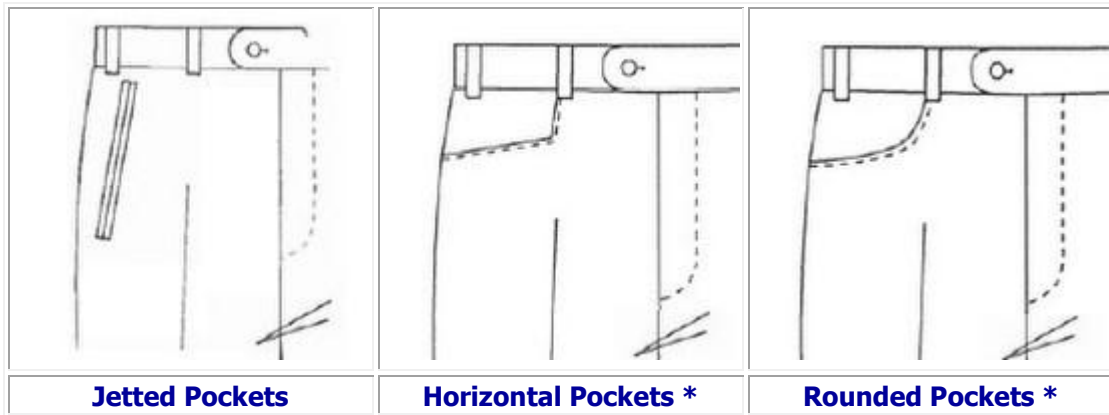

* Not compatible with pleats

Front Pockets:	Please specify
-----------------------	----------------

Belt Loops

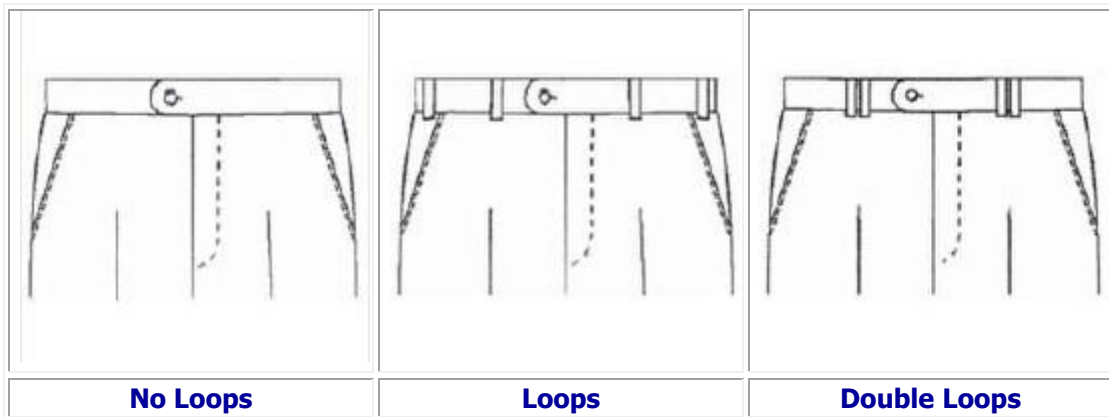

Belt Loops:	Please specify
--------------------	----------------

Pleat Style



Pleat Style:	Please specify
---------------------	----------------

Hem\Cuff

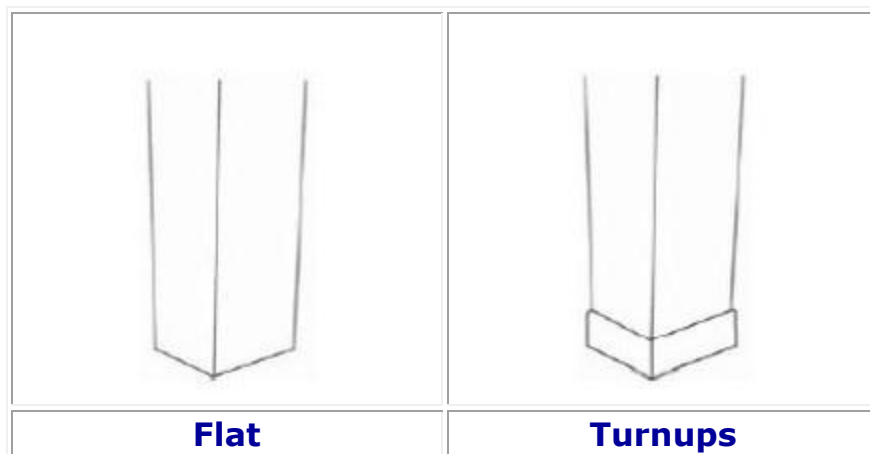

Hem\Cuff Style:	Please specify
------------------------	----------------

Satin Stripe:

A tuxedo/dinner trousers usually come with satin strip to match jacket lapels down the outside of each leg. Choose your colour, or none if you don't want satin stripe.

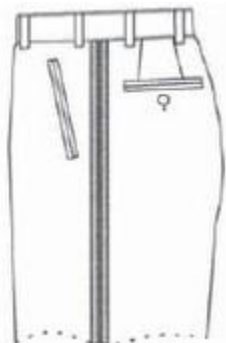

Satin Stripe:	Please specify (Black\White\None)
----------------------	-----------------------------------

Special Discount Offer:

Get an extra Pair of Trousers/Pants for the reduced price

An Extra Pair of Trousers: Please specify (Yes\No)

Waistcoat/Vest: Please specify (Yes\No)

Optional Extras: If you would like to make avail of our special discount offer or choose to have any optional extras then you will be sent an email describing how to pay the appropriate charges.

Personalise monogramming inside the Jacket:



Additional Charges (Monogram) - £10 or \$15

Personalise monogramming inside the Jacket:	Please specify Your Name
--	--------------------------

Working/Functional Button Cuffs:



Additional Charges (Working Button Cuffs) - £10 or \$15

Working/Functional Button Cuffs:	Please specify Yes or No
---	--------------------------

Contrasting Buttonholes:



Additional Charges (Contrasting Buttonholes) - £5 or \$7 :

Contrasting Buttonholes:	Please specify Yes or No
---------------------------------	--------------------------

Outside Ticket Pocket:



Additional Charges (Outside Ticket Pocket) - £5 or \$7:

Ticket Pocket :	Please specify Yes or No
------------------------	--------------------------

Step 5 (Measurements)

We know that taking measurements can be a bit tedious, so we've worked hard to make it as easy for you as possible. Please help us to create the perfect fit for you by reading the instructions carefully and giving us the correct measurements.

What will you need?

- 1) A fabric measuring tape. Please avoid string or metallic measuring tape.
- 2) Assistance from another person as it can be very difficult to measure yourself alone with the necessary accuracy.
- 3) A well fitting shirt, pair of trousers (not jeans) and a suit coat/jacket.

When taking measurements:

- 1) Always take the true measurement. Never ever! pull the measuring tape tight or give any ease.
- 2) All measurements should be made to nearest 1/2 inch.
- 3) When taking the measurements stand upright, don't slouch or bend over to read the inches as this won't give you a true measurement.
- 4) Please provide us your actual measurements and don't just mention off-the-rack sizes you wear. A custom tailored item is designed to fit your unique specifications, rather than the rough-and-ready approximations and averages used in off-the-rack clothing.

Please Ensure:

To take every possible care when measuring and preferably take all the measurements twice as your garments will be solely based on these measurements and once tailored and shipped out we will in any circumstances not be held responsible for a poorer fit caused due to any incorrect or improper measurements provided by the clients.

Preferred Fit

In order to get the type of fitting that you like, we would ask you to indicate your preferred fitting style below. Our tailors would then add the appropriate allowances to improve the fitting of the finished product.

1- The classic fit adds 3-5 inches of fullness to chest, waist and hip measures (for e.g. if the actual chest measurement is 42 inches then choosing the classic fit would give a chest of 45-47 inches for the finished suit jacket).

2- Slim fit reduces this allowance to 2-3 inches.

3- The extra full option increases it to 5-7 inches.

Fit:	Please specify (Classic\slim\extra full)
-------------	--

MEASUREMENT INFORMATION

Unit of Measurement:	Please specify (Inches\Cms)
-----------------------------	-----------------------------



Shoulder to Bust
 Measure from shoulders
 seam to bust line

Size: Please specify



Front Length
 Measure from shoulder
 seam to front waist

Size: Please specify



Jacket Length
 Measure from shoulder
 seam to jacket length

Size: Please specify



Skirt Length

Measure from waist to skirt length

Size: Please specify



Top Coat Length

Measure from shoulder seam to bottom

Size: Please specify



High Shoulders

Measure back at end of shoulders

Size: Please specify



Low Shoulders

Measure back centre armhole to other armhole

Size: Please specify



Back Length

Measure from centre shoulder to back waist

Size: Please specify



Bust

Measure largest part keep tape a little higher at the back

Size: Please specify



Bust Width

Measure the width of bust from one nipple to another

Size: Please specify



Waist

Measure natural waist line







Size: Please specify





Hips

Measure 7" below the waist or widest point of hips

Size: Please specify



 <p>Sleeves Measure from shoulder seam to waist and bend the arm Size: Please specify</p>	 <p>Cuff Measure width around the cuff Size: Please specify</p>	 <p>Neck Measure around the neck Size: Please specify</p>
 <p>Trousers "U" Crutch From the top of the waistband in front to the top of the waistband in the back Size: Please specify</p>	 <p>Slack Out Seam Measure from top of waist band to bottom of cuff Size: Please specify</p>	 <p>Slack Cuff Measure width around the cuff Size: Please specify</p>

Shoulder:

		
<p>Sloping Shoulder</p>	<p>Regular Shoulder</p>	<p>Square Shoulders</p>

Shoulder:	Please specify (sloping \regular\square shoulder)
------------------	---

Body:

		
Very Erect	Extreme Hollow Back	Extra Stout

Body:	Please specify (erect \ Extreme Hollow Back \ Extra Stout)
--------------	--